

# Classic TITAN LED Lightbar (R65 Approved)

Combining the latest LED technology with unique optics, the Classic TITAN lightbar range provides a brilliant 360° of visual warning that is ECE R65 approved.

Designed and manufactured in the UK, the Classic TITAN lightbar is built to your exact requirements, offering a variety of flexible options to suit multiple vehicle applications including hazard lights, stop/tail/indicators, external alley lights and centre illumination with optional sign writing.



## CLASSIC TITAN LED LIGHTBAR RANGE

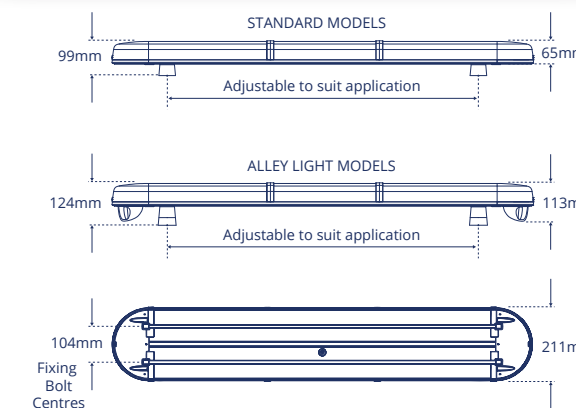

### Main Features

- Multi-voltage (10-30V)
- 2ft (0.6m), 2½ft (0.76m), 3ft (0.9m), 4ft (1.2m), 5ft (1.5m) & 6ft (1.8m) models available
- Four R65 approved flash patterns (single, double, triple, quad flash)
- Optional airport flash pattern (upon request)
- 360° high performance optics for improved safety
- Amber or clear polycarbonate lenses
- Extruded aluminium base
- Fully encapsulated electronic control module
- Long life LED technology
- Opal, clear or amber centre sections available
- 4-bolt mounting fix / high rise feet option
- Extreme temperature reliability -30° to +50°
- 2ft magnetic models available (40mph max. speed)
- 2.5 metre multi-core cable

Model shown: LB482AC/IS

### Special Request Lightbar Service

As we manufacture all our TITAN lightbars at our UK production facility we can accommodate any specification that you require. Simply contact our customer services team and we will be happy to assist.

Components	Current Consumption @ 12V	Current Consumption @ 24V
R65 LED Module (x1)	2.0A	1.0A
Centre Illumination (x1)	0.4A	0.2A
Alley Light (x1)	0.3A	0.2A
Hazard Light (x1)	0.3A	0.2A
Stop, Tail, Indicator (x1)	0.6A	0.3A
LED Worklamp (x1)	1.0A	0.5A

### CUSTOMISE YOUR CLASSIC TITAN LIGHTBAR

LED Stop, Tail, Indicator Light

External Alley Lights

Amber Lens with White LEDs

Front & Rear Hazard Lights

100mm & 150mm 'Z' Shaped Brackets

Opaque/Illuminated Centre & Signage

External LED Work Lamps

2 Head or 4 Head Options

Classic TITAN LED Lightbar Model Guide

Reflector Module 	Centre Illumination (I) 	Opaque White Centre (O) 	Stop, Tail, Indicator Light (S) <b>STI</b>	Hazard Light (H) <b>HAZ</b>	Magnetic (MAG) 	Alley Light (A) 	External LED Worklamps (X) 
----------------------	-----------------------------	-----------------------------	---	--------------------------------	--------------------	---------------------	--------------------------------

Lightbar Length - 2ft (610mm)

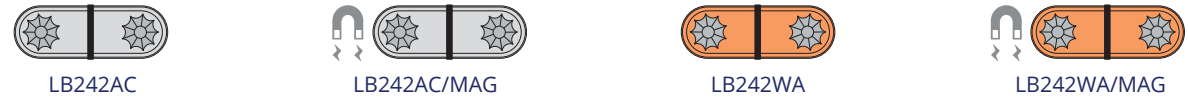

Lightbar Length - 2½ft (762mm)



Lightbar Length - 3ft (915mm)

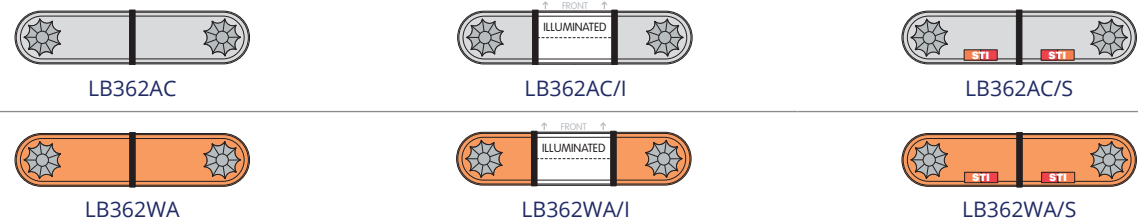

Lightbar Length - 4ft (1220mm)

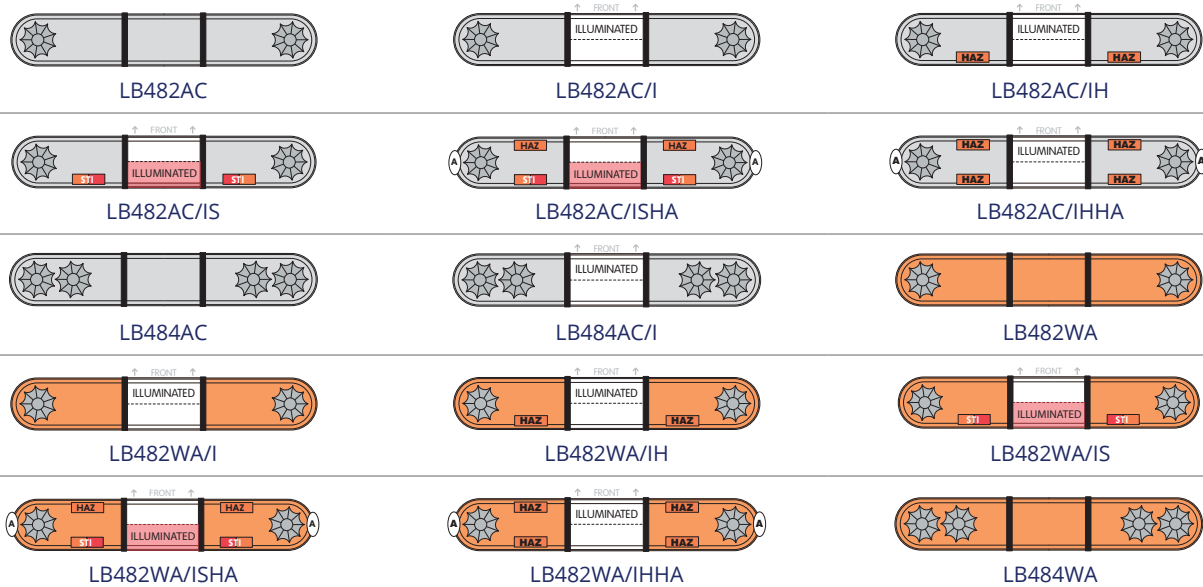

Lightbar Length - 5ft (1524mm)

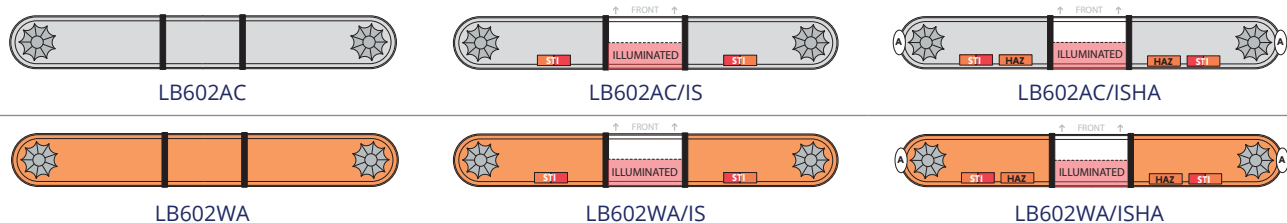

These lightbar drawings are for illustration purposes only

Classic TITAN LED Lightbar Model Guide

Reflector Module 	Centre Illumination (I) 	Opaque White Centre (O) 	Stop, Tail, Indicator Light (S) <b>STI</b>	Hazard Light (H) <b>HAZ</b>	Magnetic (MAG) 	Alley Light (A) 	External LED Worklamps (X) 
----------------------	-----------------------------	-----------------------------	---	--------------------------------	--------------------	---------------------	--------------------------------

Lightbar Length - 5ft (1524mm) continued...

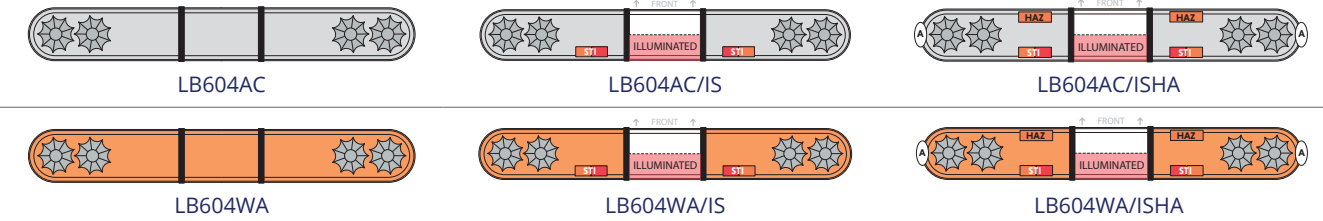

Lightbar Length - 6ft (1828mm)

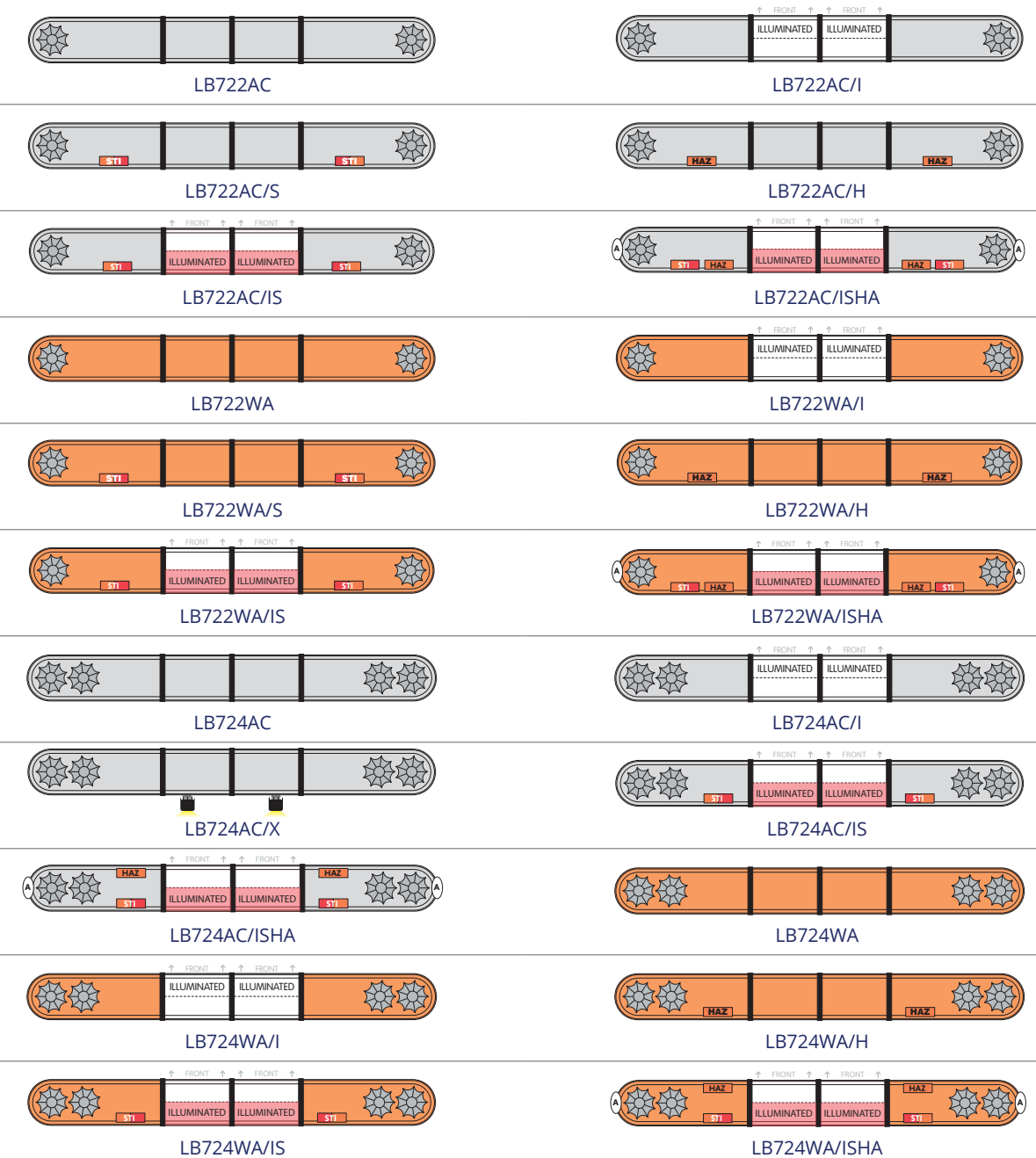

These lightbar drawings are for illustration purposes only



# Hurricane TITAN LED Lightbar (R65 Approved)

The new Hurricane TITAN can use 4 x 6 LED or 8 x 3 LED modules to create 360° of R65 approved warning light. Add extra 3 LED and 6 LED modules to your Hurricane TITAN for extra warning light.

As with other TITAN lightbars the Hurricane TITAN is customisable. Choose your perfect length and LED combination. Add a white centre with the further option of illumination or add stop/tail/indicator lights. Contact our sales team for help in finding your perfect lightbar configuration.

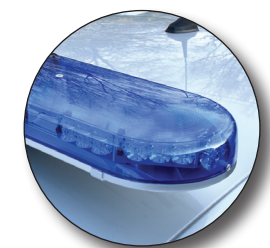

Now Available - Blue R65 Class 1 Approved (Clear & Blue Lenses)

Front facing LED illuminated centre section with optional sign writing (rear facing illumination when ordered with stop, tail, indicator light)

Stop, tail, indicator lights, hazard lights and external LED work lamps all available

Conformal coated modules manufactured with 3W LEDs

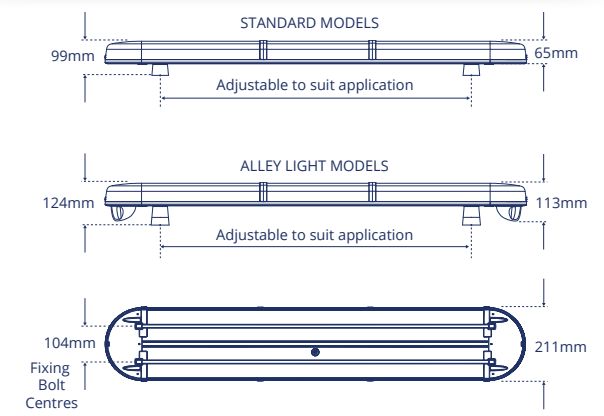

## Main Features

- Multi-voltage (10-30V)
- 2ft (0.6m), 2½ft (0.76m), 3ft (0.9m), 4ft (1.2m), 5ft (1.5m) & 6ft (1.8m) models available
- Four R65 approved flash patterns (single, double, triple, quad flash)
- Three selectable operating modes - simultaneous, left/right and front/Back
- Airport flash mode available
- Amber or clear polycarbonate lenses
- Extruded aluminium base
- Fully encapsulated electronic control module
- Opal, clear or amber centre sections available
- 4-bolt mounting fix / high rise feet option
- Extreme temperature reliability -30° to +50°
- 2ft Magnetic models available (40mph max. speed)
- 2.5 metre multi-core cable

NEW FOR 2020

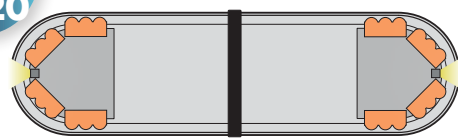

Hurricane TITAN also available with 8 x 3 LEDs & internal alley lights

Model shown: LBH604H8AC/IS

## Special Request Lightbar Service

As we manufacture all our TITAN lightbars at our UK production facility we can accommodate any specification that you require. Simply contact our customer services team and we will be happy to assist.

Components	Current Consumption @ 12V	Current Consumption @ 24V
3 LED Module (x1)	0.4A	0.2A
6 LED Module (x1)	0.9A	0.4A
Centre Illumination (x1)	0.4A	0.2A
Alley Light (x1)	0.3A	0.2A
Hazard Light (x1)	0.3A	0.2A
Stop, Tail, Indicator (x1)	0.6A	0.3A
LED Worklamp (x1)	1.0A	0.5A

## CUSTOMISE YOUR HURRICANE TITAN LIGHTBAR

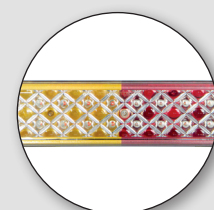

LED Stop, Tail, Indicator Light

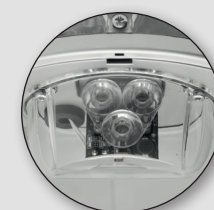

Internal & External Alley Lights



Amber Lens with White LEDs

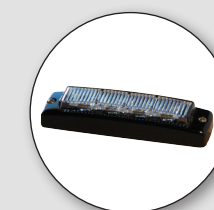

Front & Rear Hazard Lights

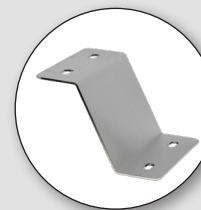

100mm & 150mm 'Z' Shaped Brackets



Opaque/Illuminated Centre & Signage



External LED Work Lamps

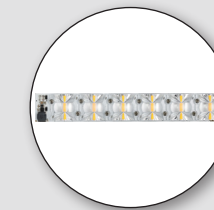

Extra 3 & 6 LED Modules

Hurricane TITAN LED Lightbar Model Guide

3 & 6 LED Amber Modules	3 & 6 LED White Modules	Centre Illumination (I)	Opaque White Centre (O)	Stop, Tail, Indicator Light (S)	Magnetic (MAG)	Alley Light (A)	External LED Worklamps (X)

Lightbar Length - 2ft (610mm)

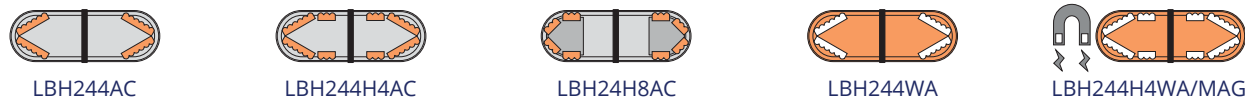

Lightbar Length - 2½ft (762mm)

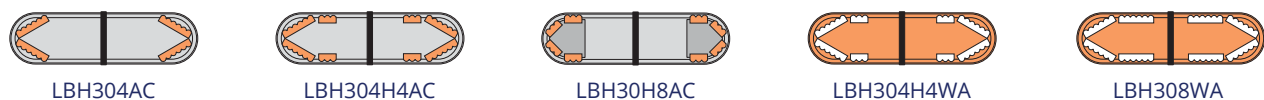

Lightbar Length - 3ft (915mm)

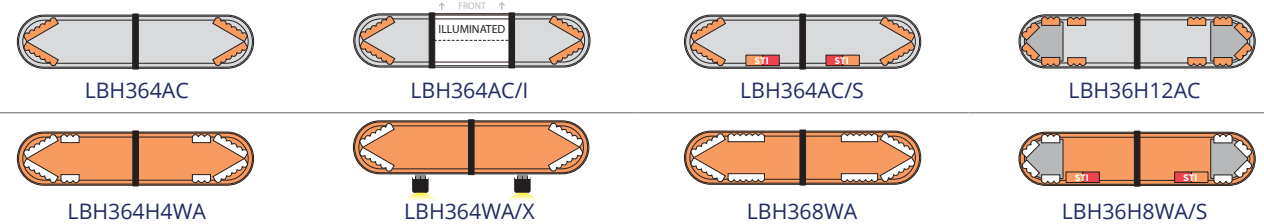

Lightbar Length - 4ft (1220mm)

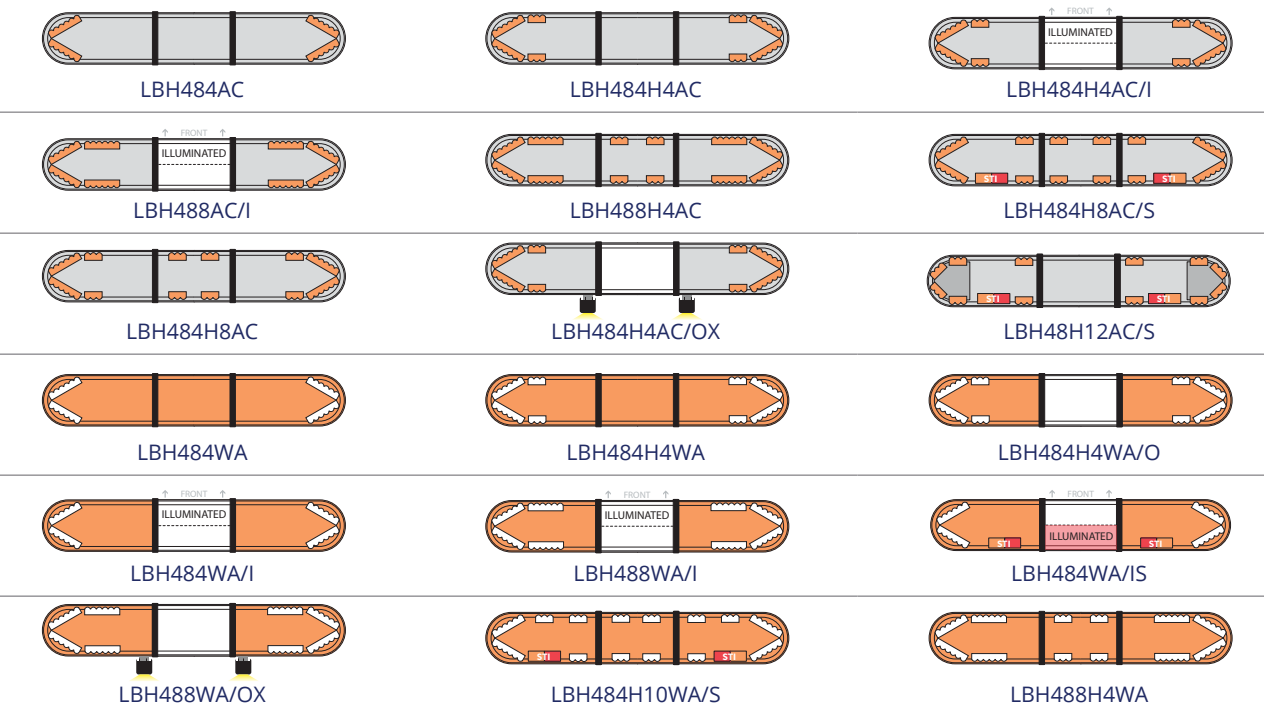

Hurricane TITAN LED Lightbar Model Guide

3 & 6 LED Amber Modules	3 & 6 LED White Modules	Centre Illumination (I)	Opaque White Centre (O)	Stop, Tail, Indicator Light (S)	Magnetic (MAG)	Alley Light (A)	External LED Worklamps (X)

Lightbar Length - 5ft (1524mm)

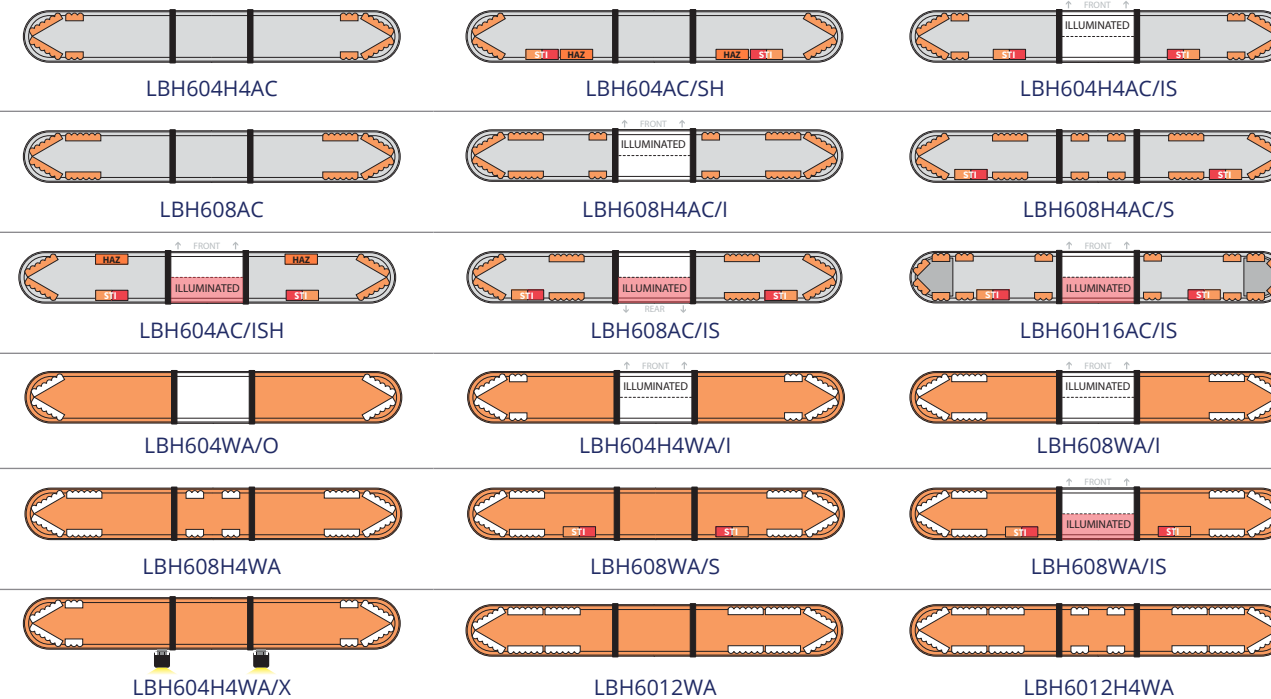

Lightbar Length - 6ft (1828mm)

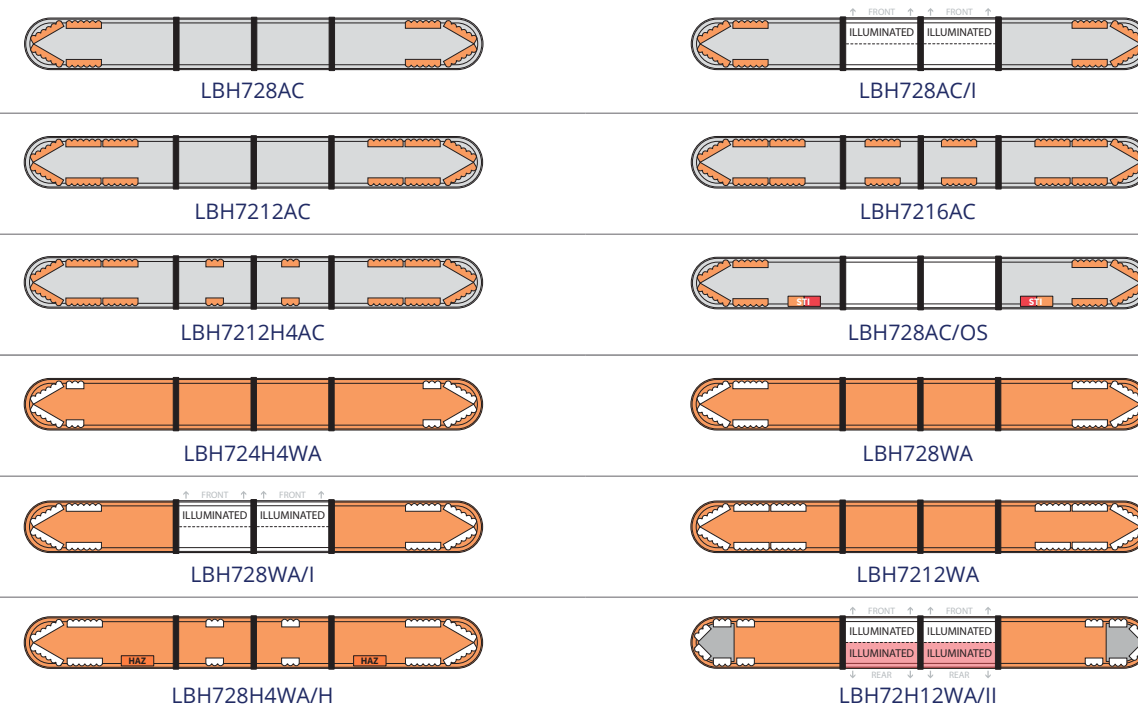



# Lightning TITAN LED Lightbar (R65 Approved)

Featuring four ECE R65 approved flash patterns and three operating modes, the Lightning TITAN LED lightbar is a highly versatile addition to our UK manufactured lightbar range.

The advanced electronic control unit of the Lightning TITAN lightbar enables additional front and rear facing LED modules to be specified for enhanced visual warning.

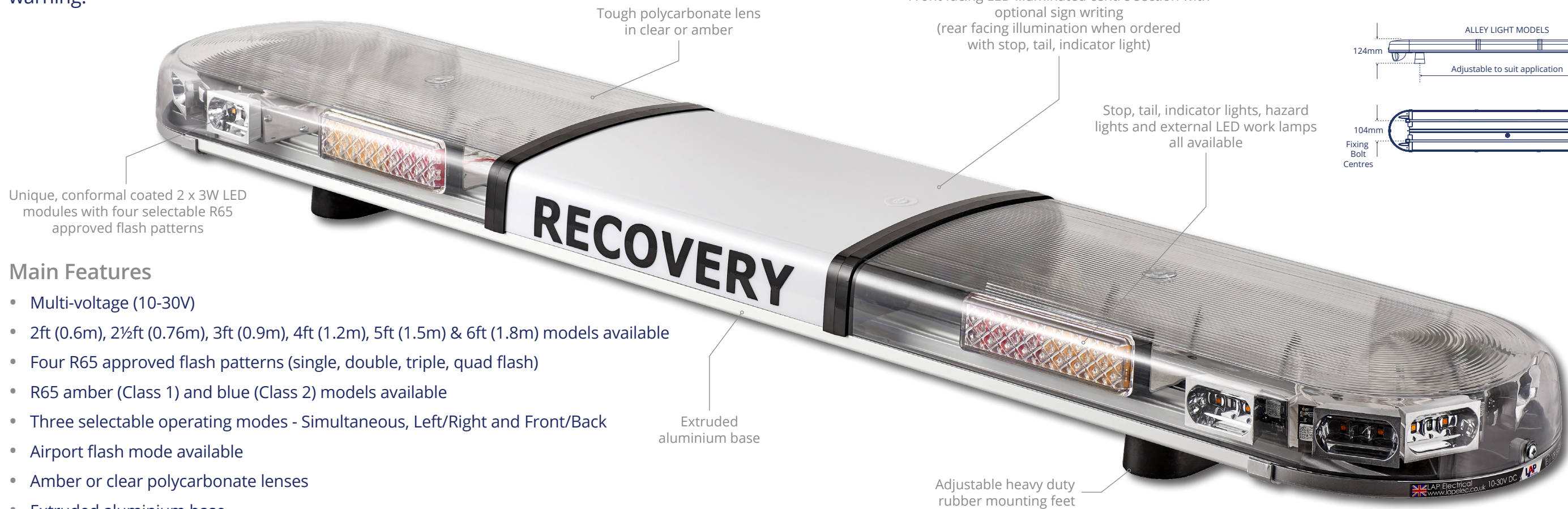
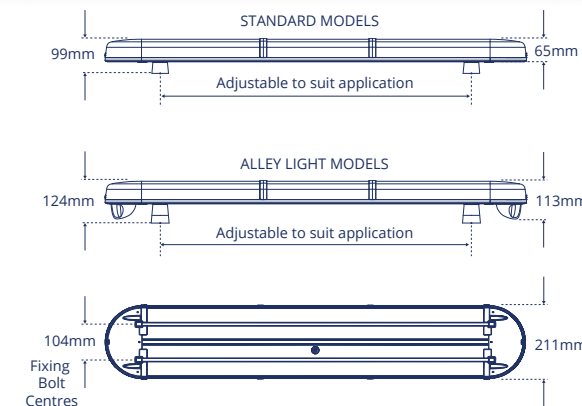

## Main Features

- Multi-voltage (10-30V)
- 2ft (0.6m), 2½ft (0.76m), 3ft (0.9m), 4ft (1.2m), 5ft (1.5m) & 6ft (1.8m) models available
- Four R65 approved flash patterns (single, double, triple, quad flash)
- R65 amber (Class 1) and blue (Class 2) models available
- Three selectable operating modes - Simultaneous, Left/Right and Front/Back
- Airport flash mode available
- Amber or clear polycarbonate lenses
- Extruded aluminium base
- Fully encapsulated electronic control module
- Opal, clear or amber centre sections available
- 4-bolt mounting fix / high rise feet option
- Extreme temperature reliability -30° to +50°
- 2ft Magnetic models available (40mph max. speed)
- 2.5 metre multi-core cable

Model shown: LBL4812AC/IS

### Special Request Lightbar Service

As we manufacture all our TITAN lightbars at our UK production facility we can accommodate any specification that you require. Simply contact our customer services team and we will be happy to assist.

Components	Current Consumption @ 12V	Current Consumption @ 24V
R65 LED Module (x1)	0.5A	0.3A
Centre Illumination (x1)	0.4A	0.2A
External Alley Light (x1)	0.3A	0.2A
Hazard Light (x1)	0.3A	0.2A
Stop, Tail, Indicator (x1)	0.6A	0.3A
LED Worklamp (x1)	1.0A	0.5A

### CUSTOMISE YOUR LIGHTNING TITAN LIGHTBAR

Lightning TITAN LED Lightbar Model Guide

2 LED Module - Amber 	2 LED Module - White 	Centre Illumination (I) 	Opaque White Centre (O) 	Stop, Tail, Indicator Light (S) <b>STI</b>	Hazard Light (H) <b>HAZ</b>	Magnetic (MAG) 	Alley Light (A) 	External LED Worklamps (X) 
--------------------------	--------------------------	-----------------------------	-----------------------------	---	--------------------------------	--------------------	---------------------	--------------------------------

Lightbar Length - 2ft (610mm)



Lightbar Length - 2½ft (762mm)



Lightbar Length - 3ft (915mm)

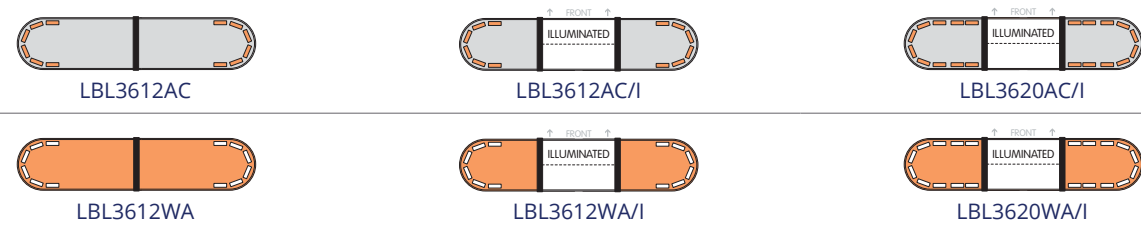

Lightbar Length - 4ft (1220mm)

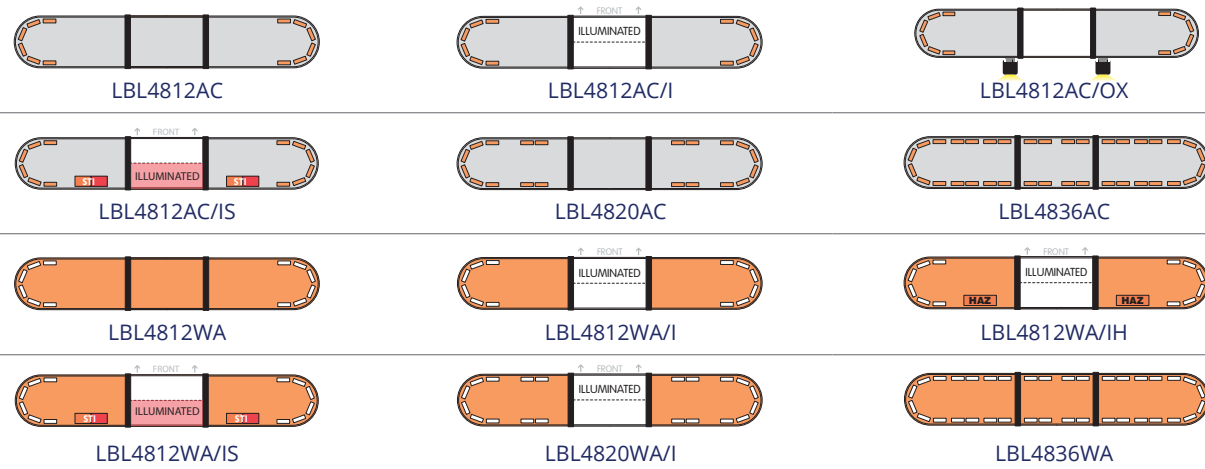

Lightning TITAN LED Lightbar Model Guide

2 LED Module - Amber 	2 LED Module - White 	Centre Illumination (I) 	Opaque White Centre (O) 	Stop, Tail, Indicator Light (S) <b>STI</b>	Hazard Light (H) <b>HAZ</b>	Magnetic (MAG) 	Alley Light (A) 	External LED Worklamps (X) 
--------------------------	--------------------------	-----------------------------	-----------------------------	---	--------------------------------	--------------------	---------------------	--------------------------------

Lightbar Length - 5ft (1524mm)

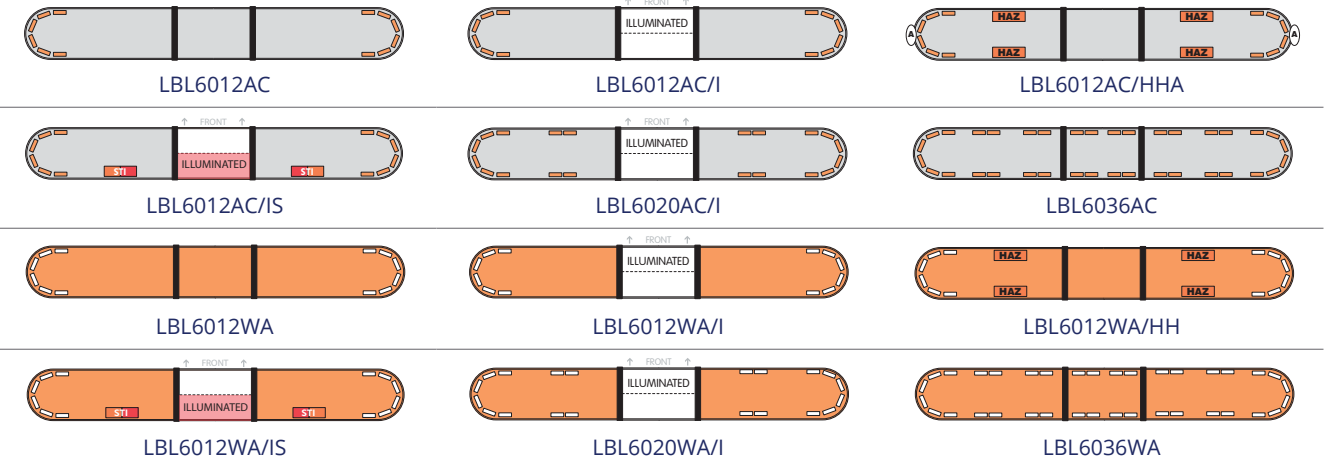

Lightbar Length - 6ft (1828mm)

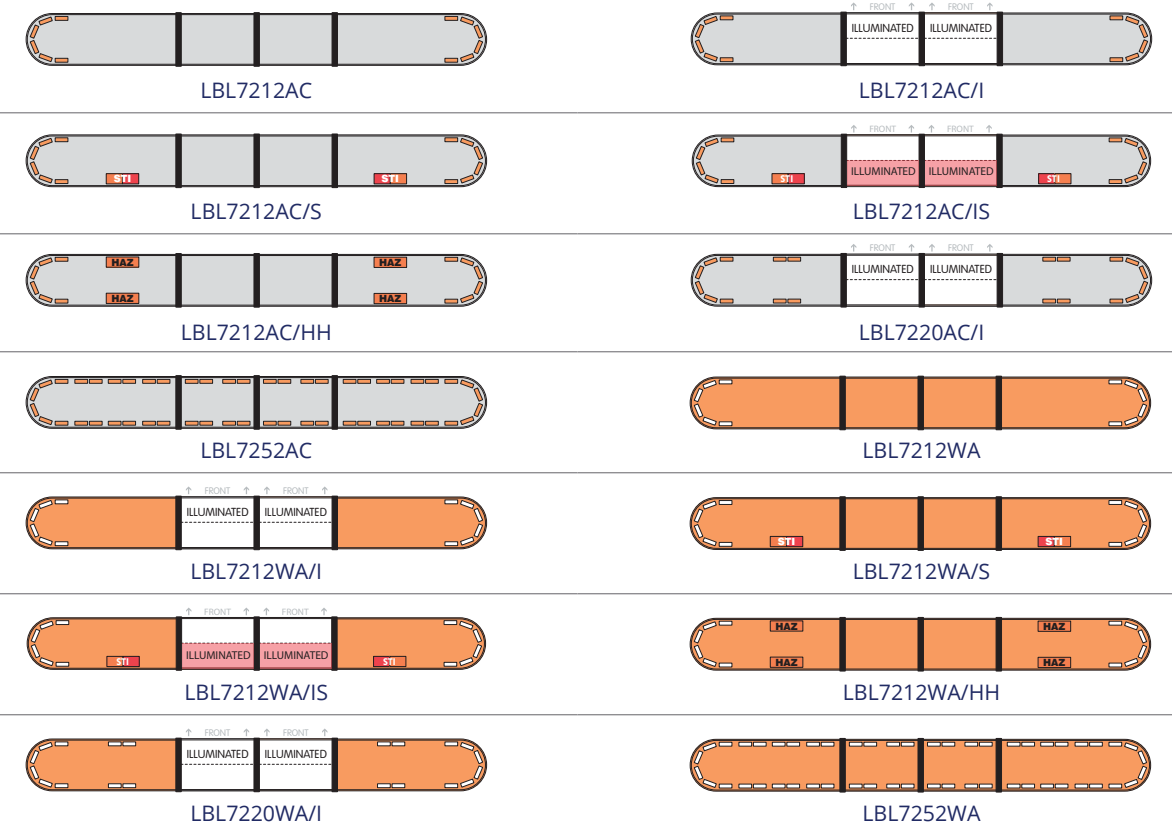



# Tornado TITAN LED Lightbar (R65 Approved)

The Tornado TITAN combines the latest LED and reflector technologies with the taller profile lens of the Rotating TITAN.

Designed with ECE R65 approved double flash only, the Tornado is the best value member of the TITAN LED family and is supplied with 2 x 45 LED reflector heads as standard.

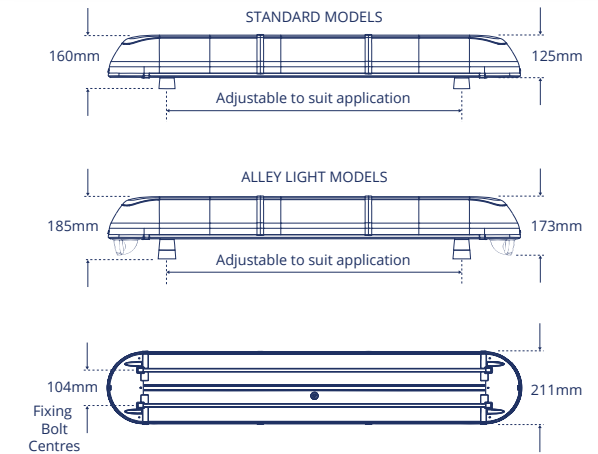

## Main Features

- Multi-voltage (10-30V)
- 2ft (0.6m), 2½ft (0.76m), 3ft (0.9m), 4ft (1.2m), 5ft (1.5m) & 6ft (1.8m) models available
- ECE R65 approved double flash pattern
- Amber polycarbonate lenses
- Extruded aluminium base
- Opal or amber centre sections available
- 4-bolt mounting fix / high rise feet option
- Extreme temperature reliability -30° to +50°
- 2ft magnetic model available (40mph max. speed)
- 2.5 metre multi-core cable



Model shown: LBT242A

Components	Current Consumption @ 12V	Current Consumption @ 24V
R65 LED Module (x1)	2.0A	1.0A
Centre Illumination (x1)	0.4A	0.2A
Alley Light (x1)	0.3A	0.2A
Hazard Light (x1)	0.3A	0.2A
Stop, Tail, Indicator (x1)	0.6A	0.3A
LED Worklamp (x1)	1.0A	0.5A

## Special Request Lightbar Service

As we manufacture all our TITAN lightbars at our UK production facility we can accommodate any specification that you require. Simply contact our customer services team and we will be happy to assist.

Model shown: LBT482A/IH

### CUSTOMISE YOUR TORNADO TITAN LIGHTBAR

LED Stop, Tail, Indicator Light

External Alley Lights

Two or Four LED Head Options

Front & Rear Hazard Lights

100mm & 150mm 'Z' Shaped Brackets

Opaque/Illuminated Centre & Signage

External LED Work Lamps

Lengths from 2ft to 6ft

## Tornado TITAN LED Lightbar Model Guide

45 LED Module 	Centre Illumination (I) 	Opaque White Centre (O) 	Stop, Tail, Indicator Light (S) 	Hazard Light (H) 	Magnetic (MAG) 	Alley Light (A) 	External LED Worklamps (X) 
--	--	--	--	---	---	--	---

### Lightbar Length - 2ft (610mm)



LBT242A

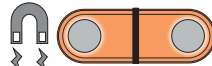

LBT242A/MAG

### Lightbar Length - 2½ft (762mm)



LBT302A



LBT302A/I



LBT304A

### Lightbar Length - 3ft (915mm)



LBT362A

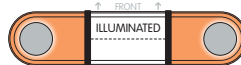

LBT362A/I



LBT362A/S

### Lightbar Length - 4ft (1220mm)



LBT482A



LBT482A/I



LBT482A/IS



LBT482A/IH



LBT484A/IX



LBT484A/I

### Lightbar Length - 5ft (1524mm)



LBT602A



LBT604A



LBT604A/I



LBT604A/SA



LBT604A/IHH



LBT604A/IS

### Lightbar Length - 6ft (1828mm)



LBT722A



LBT724A

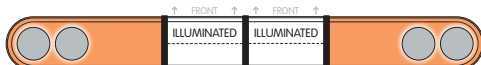

LBT724A/I



LBT724A/S

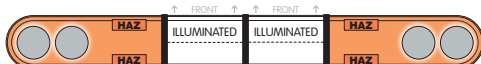

LBT724A/IHH

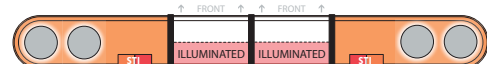

LBT724A/IS