

REAR LAMPS

Our range of Commercial Vehicle Lighting products include the latest long life LEDs which provide bright and reliable, maintenance-free operation. The LAP Commercial Vehicle LED lighting range is covered by a 5 year warranty.

26004 Series



26004N-1



26004N-2



26004N-3

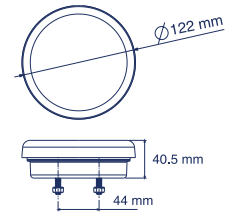

Part No	Voltage	Stop	Tail	Reverse	D.I.	Fog	Connector	ECE
26004N-1	12/24V	✓	✓		✓		200mm cable	✓
26004N-2	12/24V			✓	✓		200mm cable	✓
26004N-3	12/24V				✓	✓	200mm cable	✓

26011 Series



26011K-1



26011K-2

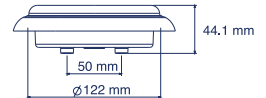
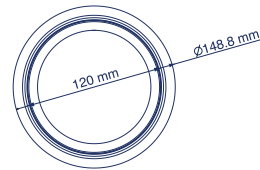
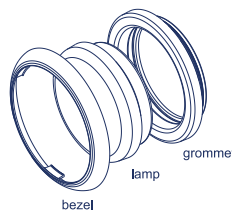

Part No	Voltage	Stop	Tail	Reverse	D.I.	Connector	ECE
26011K-1	12/24V	✓	✓		✓	400mm cable	✓
26011K-2	12/24V			✓	✓	400mm cable	✓

26000 Series

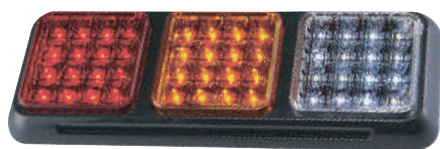

26000RAC-BV



26000RAR-1BV

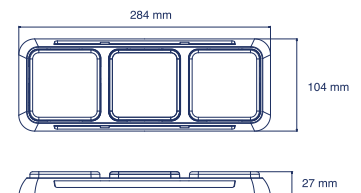

Part No	Voltage	Stop	Tail	Reverse	D.I.	Fog	Connector	ECE
26000RAC-BV	12/24V	✓	✓	✓	✓		400mm cable	✓
26000RAR-1BV	12/24V	✓	✓		✓	✓	400mm cable	✓

26001 Series



26001AR-BV

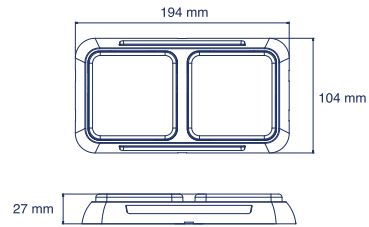

Part No	Voltage	Stop	Tail	D.I.	Connector	ECE
26001AR-BV	12/24V	✓	✓	✓	400mm cable	✓

26002 Series



26002AR

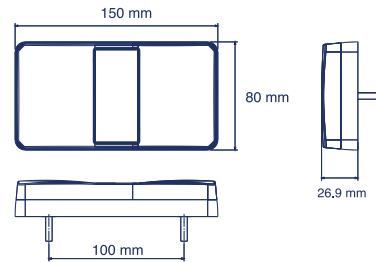

Part No	Voltage	Stop	Tail	D.I.	Reflex	Connector	ECE
26002AR	12/24V	✓	✓	✓	✓	300mm cable	✓

26018 Series



26018C-BV



26018R-1BV

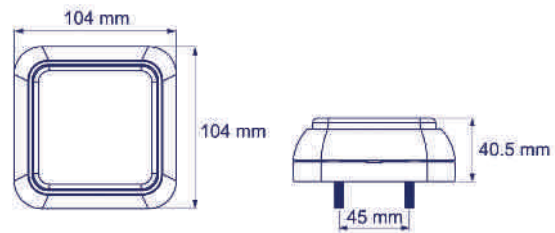

Part No	Voltage	Reverse	Fog	Connector	ECE
26018C-BV	12/24V	✓		200mm cable	✓
26018R-1BV	12/24V		✓	200mm cable	✓

26027 Series



26027

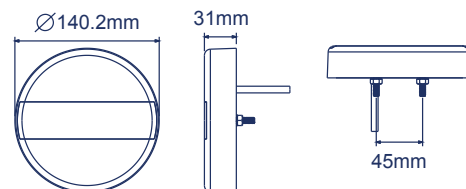

Part No	Voltage	Stop	Tail	D.I.	Connector	ECE
26027	24V	✓	✓	✓	200mm cable	✓



REAR LAMPS AND REFLECTORS

26010 Series



26010HL-V

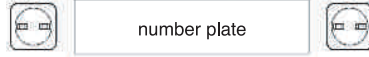

number plate

520x120 mm

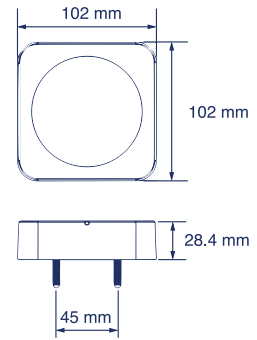

Part No	Voltage	Handed	Stop	Tail	D.I.	License	Reflex	Connector	ECE
26010HL-V	12/24V	RH & LH	✓	✓	✓	✓	✓	500mm cable	✓

26006 Series



RH model shown illuminated

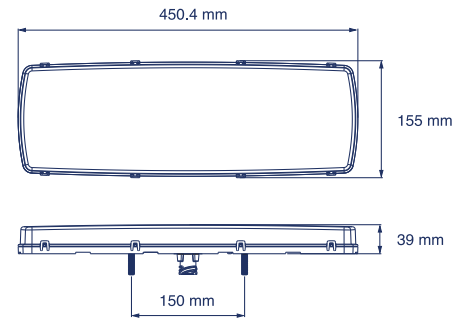
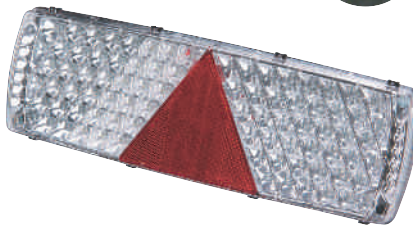

Part No	Voltage	Stop	Tail	Reverse	D.I.	Fog	Side Marker	Reflex	Connector	ECE
26006RH	12/24V	✓	✓	✓	✓	✓	✓	✓	7-pin	✓
26006LH	12/24V	✓	✓	✓	✓	✓	✓	✓	7-pin	✓

Reflex Reflectors 47001 Series



47001A



47001R



47001C

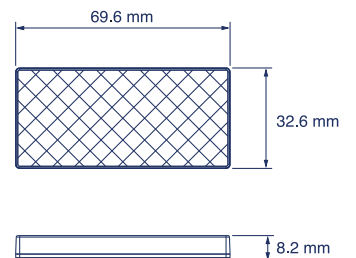

Part No	Colour	Adhesive	ECE
47001A	Amber	✓	✓
47001R	Red	✓	✓
47001C	White	✓	✓

MARKER LAMPS

26258 Series (Side)

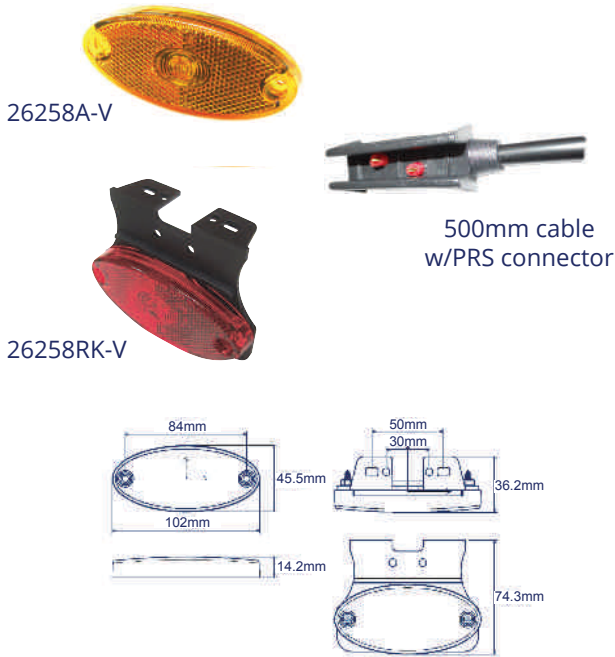

Part No	Voltage	Colour	Bracket	ECE
26258A-V	12/24V	Amber		✓
26258AK-V	12/24V	Amber	✓	✓
26258R-V	12/24V	Red		✓
26258RK-V	12/24V	Red	✓	✓
26258C-V	12/24V	White		✓
26258CK-V	12/24V	White	✓	✓

26550 Series



Part No	Voltage	Handed	ECE
26550-2VRH	12/24V	Right Hand	✓
26550-2VLH	12/24V	Left Hand	✓

26259 Series (Outline)

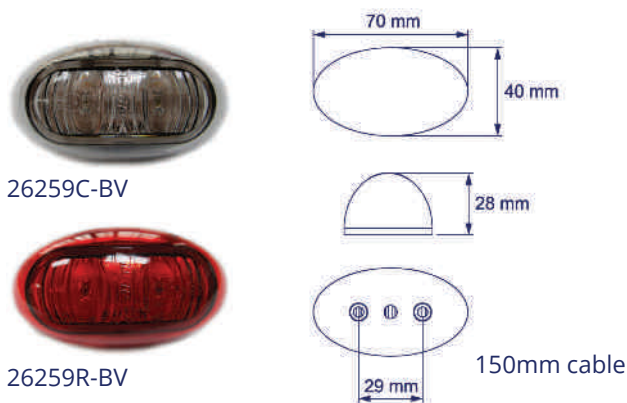

Part No	Voltage	Colour	ECE
26259C-BV	12/24V	White	✓
26259R-BV	12/24V	Red	✓

26256 Series - Number Plate Lamp



Part No	Voltage	Connector	ECE
26256CK-G	12/24V	450mm fly lead	✓



INTERIOR LAMPS

Strip Lights

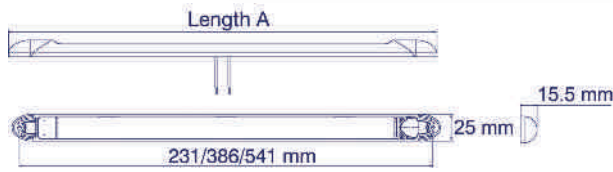

Main Features

- EMC approved (ECE R10)
- Integral on/off switch for maximum versatility
- Water, dust and shock resistant
- Operating temperature: -30 to +50 °C
- Wiring: 100mm fly lead
- 5 year warranty

Part No	Voltage	Length A	Current Consumption 12/24V	Lumen	Candela	Number of LEDs
22785CK5-WV	12/24V	245mm	0.3/0.2A	300	60	9
22776CK5-WV	12/24V	400mm	0.5/0.2A	600	130	18
22762S-12V	12V	555mm	0.6A	378	420	27
22762S-24V	24V	555mm	0.59A	378	420	27

Circular Lights

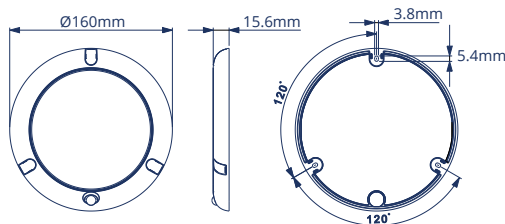

Main Features

- Ultra low profile
- Built-in motion detecting PIR sensor for automatic switch on
- Non-PIR models can be controlled by a linked PIR model
- Water, dust and shock resistant
- Operating temperature: -30 to +50 °C
- IP67 Ingress Protection

Part No	Voltage	SMD LEDs	Current Consumption 12/24V	Lumen	Candela	PIR Sensor	Connection
22791CP-V	12/24V	21	0.5/0.25A	1400	160	✓	180mm cable
22791C-V	12/24V	21	0.5/0.25A	1400	160		180mm cable