

# CLASSIC TITAN LED LIGHTBARS

Combining the latest LED technology with unique optics, the CLASSIC TITAN lightbar range provides a brilliant 360° of visual warning that is ECE R65 approved.

Designed and manufactured in the UK, the CLASSIC TITAN lightbar is built to your exact requirements, offering a variety of flexible options to suit multiple vehicle applications including hazard lights, stop/tail/indicators, alley lights and centre illumination with optional sign writing.



# CLASSIC TITAN LED LIGHTBAR RANGE

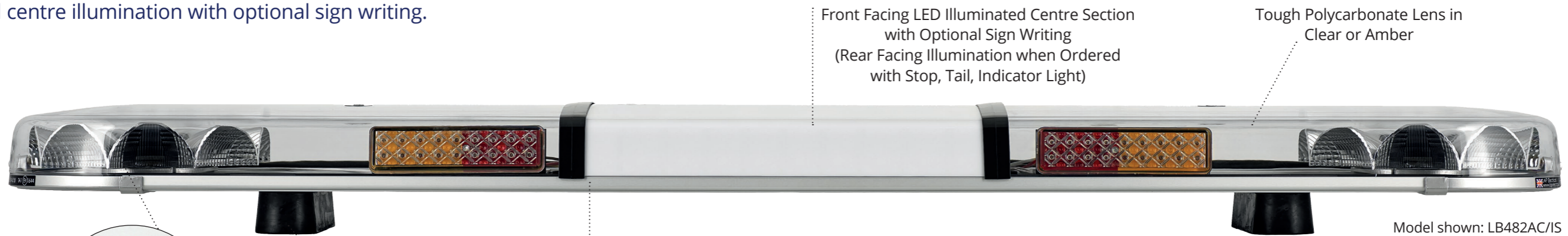

Model shown: LB482AC/IS

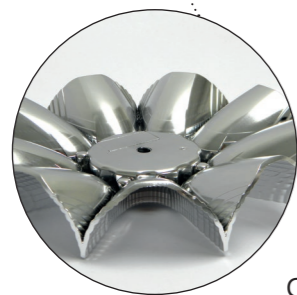

Adjustable Heavy Duty Rubber Mounting Feet  
 Extruded Aluminium Base  
 Unique 360° R65 Warning Module  
 9 x 3W Osram LEDs per Head -  
 Conformal Coated PCB - Four selectable  
 R65 approved flash patterns

## Main Features

- Dual Voltage (12/24V)
- 2ft (0.6m), 2½ft (0.76m), 3ft (0.9m), 4ft (1.2m), 5ft (1.5m) & 6ft (1.8m) models available
- Four R65 approved flash patterns (single, double, triple, quad flash)
- Optional airport flash pattern (upon request)
- 360° high performance optics for improved safety
- Amber or clear polycarbonate lenses
- Extruded aluminium base
- Fully encapsulated electronic control module
- Long life LED technology
- Opal, clear or amber centre sections available
- 4 bolt mounting fix / High rise feet option
- Extreme temperature reliability -30° to +50°
- 2ft Magnetic models available
- 2.5 metre multi-core cable

OPTIONAL EXTRAS AVAILABLE

LED Stop, Tail, Indicator Light    LED R65 Directional Hazard Light    LED Alley Light Configuration    Sign Writing

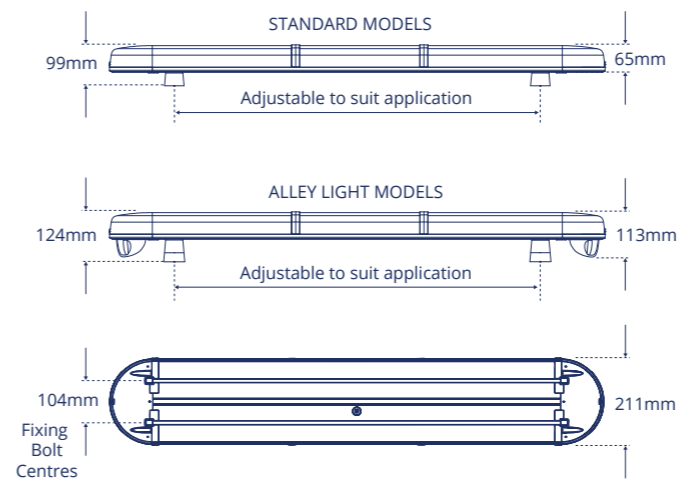

Now available with blue LEDs - R65 Class 1 Approved (clear lens)

**Special request lightbar service**  
 As we manufacture all our TITAN lightbars at our UK production facility we can accommodate any specification that you require. Simply contact our customer services team and we will be happy to assist.

Components	Current Consumption 12V	Current Consumption 24V
R65 LED Module (x1)	2.00A	1.00A
Centre Illumination (x1)	0.40A	0.20A
Alley Light (x1)	0.30A	0.15A
Hazard Light (x1)	0.30A	0.15A
Stop, Tail, Indicator (x1)	0.60A	0.30A

### CLASSIC TITAN LED LIGHTBAR Model Guide

These lightbar drawings are for illustration purposes only

Reflector Module 	Stop, Tail, Indicator Light <b>STI</b>	Hazard Light <b>HAZ</b>	Alley Light <b>A</b>	Magnetic 
---	---	----------------------------	-------------------------	---

#### Lightbar Length - 2ft (610mm)



#### Lightbar Length - 2½ft (762mm)



#### Lightbar Length - 3ft (915mm)

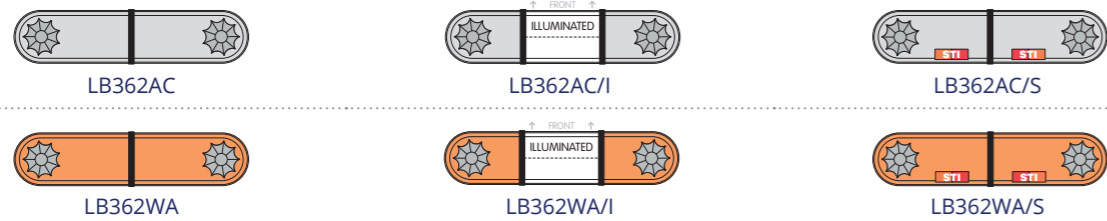

#### Lightbar Length - 4ft (1220mm)

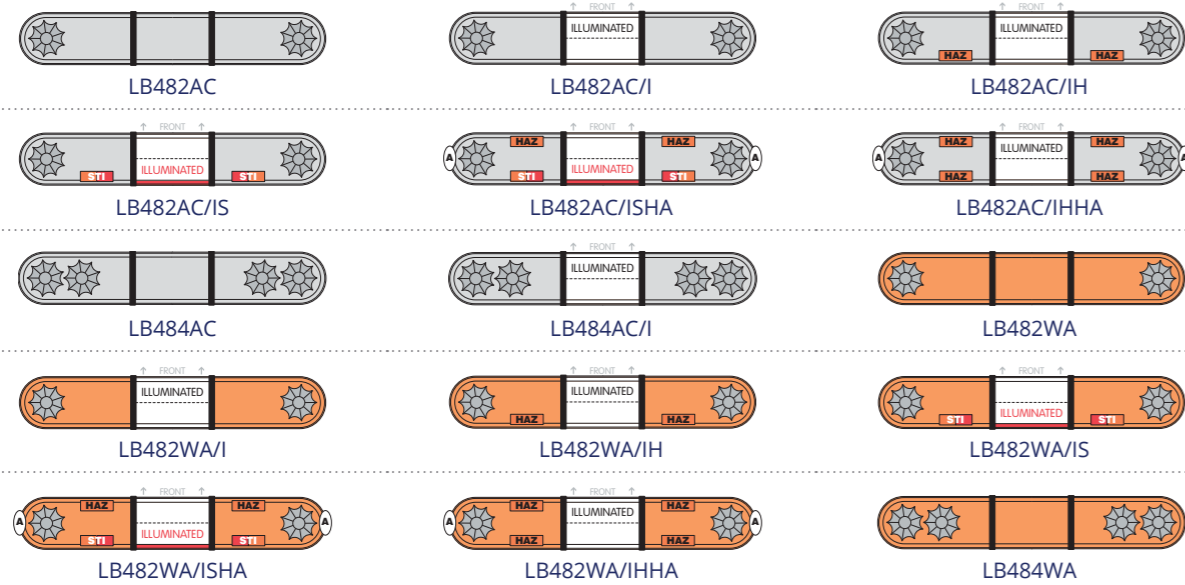

#### Lightbar Length - 5ft (1524mm)

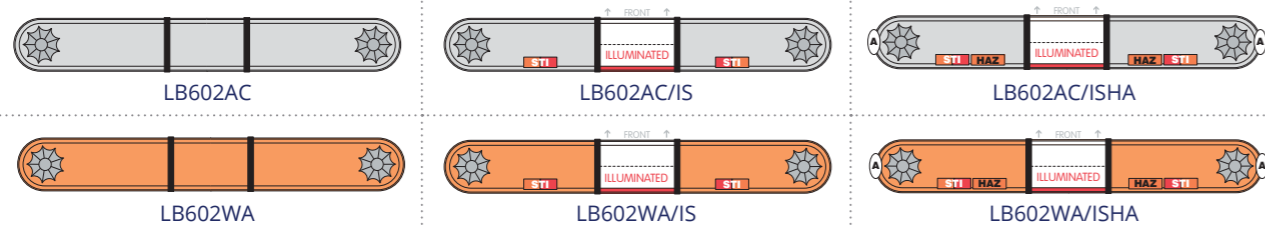

### CLASSIC TITAN LED LIGHTBAR Model Guide

These lightbar drawings are for illustration purposes only

Reflector Module 	Stop, Tail, Indicator Light <b>STI</b>	Hazard Light <b>HAZ</b>	Alley Light <b>A</b>	Magnetic 
---	---	----------------------------	-------------------------	---

#### Lightbar Length - 5ft (1524mm) continued...

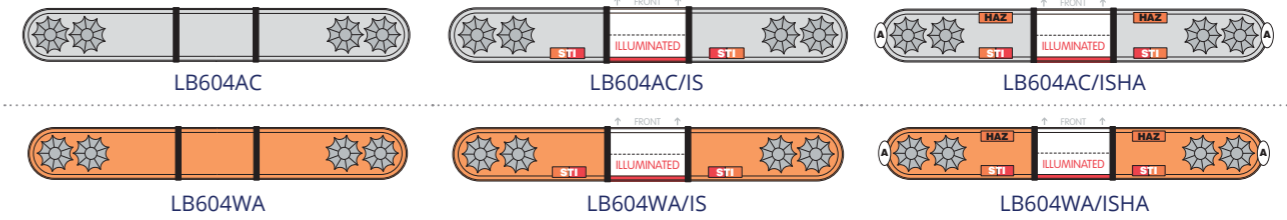

#### Lightbar Length - 6ft (1828mm)

